



Australia

# STAND OUT WITH ANTARES



**7 & 9 INCH DRIVING LIGHT KIT**

1F7 358 228-861 & 1F0 358 228-871

# STAR LIGHT. STAR BRIGHT.

**STAND OUT FROM THE CROWD** WITH THE ALL NEW HELLA ANTARES LED DRIVING LIGHTS.

Named after the radiant Antares star, these driving lights are engineered to illuminate the darkest roads, ensuring your journey is safe and spectacular.

Co-designed in Australia for Australian roads, the Antares is sure to meet all your needs and more.

## SAFETY & VISIBILITY DAY & NIGHT

- Daytime Running Lamps provide visibility during daylight to alert oncoming traffic
- Unique look position lamps increase visibility in urban environments

## SELECTABLE OUTPUT MODES (9 INCH ONLY)

- Easily adjust between high and low output for optimal driver comfort

## DIECAST ALUMINUM HOUSING & BRACKET

- Durable, lightweight and corrosion resistant
- Mounting holes for maximum stability

## TOUGH DRL INTEGRATED COVERS

- Provides stylish protection against sand, dust, mud and bugs.
- Includes distinctive Antares edgelight design



## COMPOSITE LIGHTING DESIGN

- Projector spot beams for exceptional distance
- Diamond glow position lamp with unique umbrella reflector technology
- Wide beam 10W LED clusters for even wider light dispersal

## COVER DETECTION

- Switches off main beam when cover applied for greater operating efficiency

## TOUGH CONSTRUCTION

- IP69K dust & waterproof, suits harsh Australian conditions
- Hard-coated UV stable polycarbonate lens

## PLUG & PLAY WIRING HARNESS

- With H4 & HB3 adaptors for easy DIY install



## TAKE CONTROL OF YOUR LIGHTING WITH A MULTITUDE OF HELLA LIGHTING TECHNOLOGIES FOR SAFETY AND VISIBILITY, DAY AND NIGHT.

Hella's brilliance isn't just about lighting up the dark—it's about lighting intelligence. With the Antares driving lights, you get the best of both worlds: a light so bright it outshines the stars, and technology so smart, it outshines the rest.



ACTIVE THERMAL  
MANAGEMENT



ELECTROMAGNETIC  
COMPATIBILITY



POLARITY REVERSAL  
PROTECTION



OVERVOLTAGE  
PROTECTION



MATERIAL OF  
THE HOUSING:  
ALUMINIUM



MATERIAL OF  
THE LENS:  
PC (POLYCARBONATE)



MATERIAL OF  
THE BRACKET:  
ALUMINIUM



UPRIGHT  
MOUNT



VIBRATION  
RESISTANT



WATER  
RESISTANT



HIGH-QUALITY  
MATERIAL



WIRING  
HARNESS

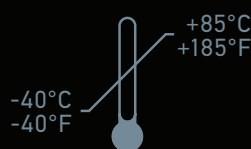

STORAGE  
TEMPERATURE

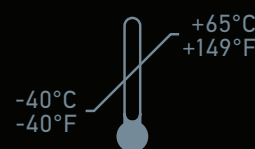

AMBIENT  
TEMPERATURE

### KIT INCLUDES:

- 2x LED spotlight with mounting hardware
- 2x LED spotlight covers
- 2x adaptor (H4 & HB3)
- 1x wiring harness
- 1x mounting instructions



LED Spotlight



LED Spotlight  
cover



Adaptors (H4 & HB3)

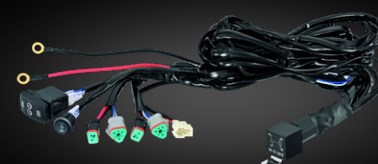

Wiring harness including relay,  
switches x2, DT connections

# ANTARES 9-INCH

## FOR ULTIMATE VISIBILITY, LOOK NO FURTHER THAN THE ANTARES 9-INCH.

With high and low output modes, you get the perfect balance of intense long-range illumination and reduced glare for on-road driving—making every journey safer, clearer, and more controlled.

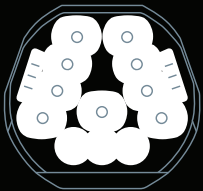

**HIGH  
OUTPUT MODE**

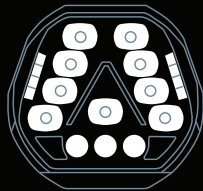

**LOW  
OUTPUT MODE**



**DAYTIME  
RUNNING LIGHT**

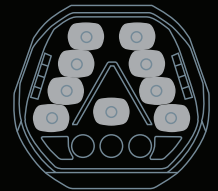

**POSITION  
LIGHT**

The Hella Antares integrates lighting techniques mastered in collaboration with the largest automotive brands and decades of Australia's harshest driving conditions, creating a composite beam that delivers incredibly constant and impressive output:

- 80m wide beam exceeds 150m distance with the ultra-wide specific LED clusters
- Impressive mid-range width of 46m that exceeds 650m distance with the umbrella LED optic
- Precision Projector LED gives a total distance exceeding 800m
- All at the industry standard 1 Lux.

HIGH OUTPUT MODE

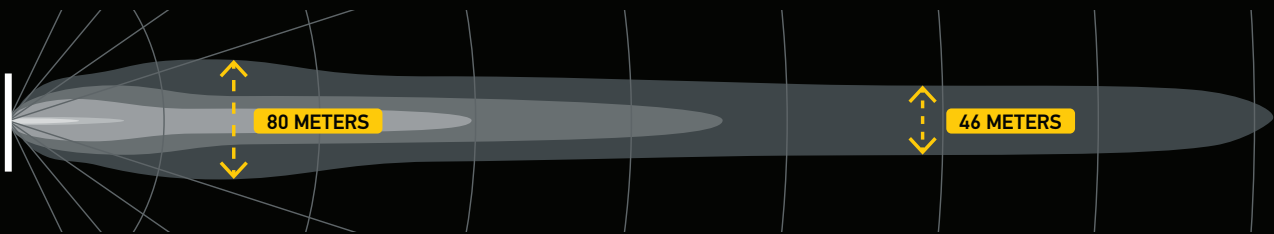

LOW OUTPUT MODE (ECE)

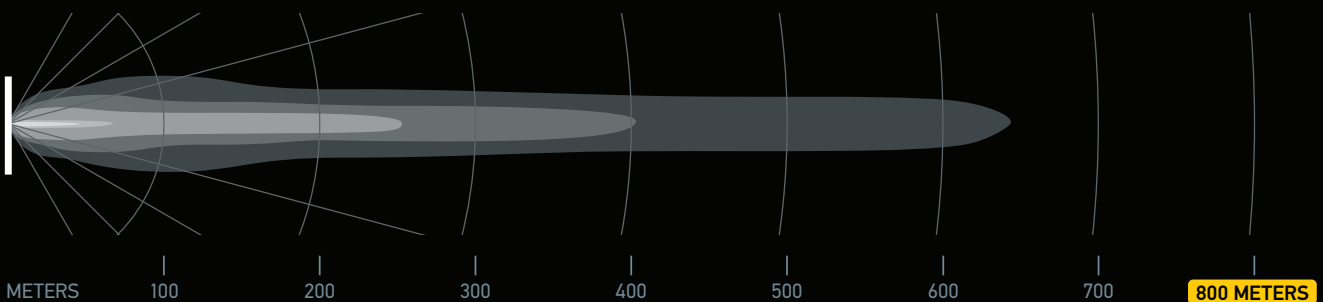

METERS

100

200

300

400

500

600

700

800 METERS

LUX

1000

100

10

5

1

ISOLUX = 2 LIGHTS

# ANTARES 9-INCH

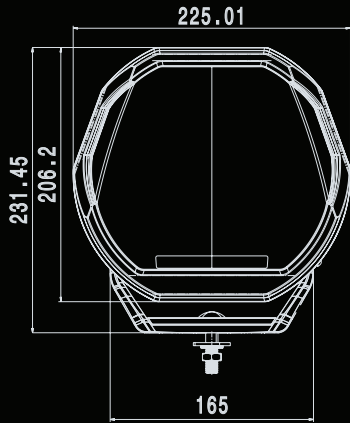

FRONT VIEW

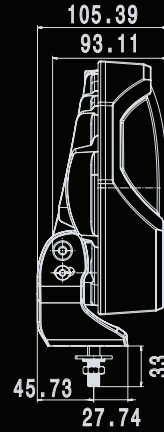

LEFT VIEW

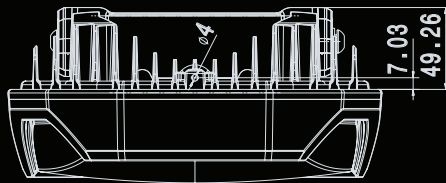

TOP VIEW

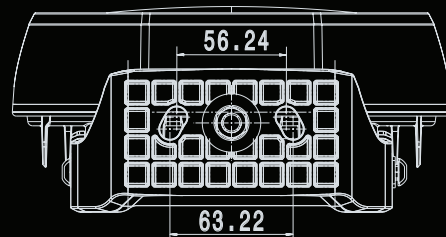

BOTTOM VIEW

## TECHNICAL INFORMATION FOR 1 LIGHT



### HIGH OUTPUT MODE

13.5V: 14.1A±10%  
28V: 6.1A±10%

### LOW OUTPUT MODE

13.5V: 11.4A±10%  
28V: 5.5A±10%

### DAYTIME RUNNING LIGHT

13.5V: 1.18A±10%  
28V: 0.57A±10%

### POSITION LIGHT

13.5V: 0.36A±10%  
28V: 0.128A±10%

2200 g	LED 52x	5700K
8500 LUMEN	IP69K IP67	10-30V DC
215W HIGH	120W LOW	RoHS

ECE R10 (CISPR25 CLASS 3)  
R148 (R7), R149 (R112), R87

ADR 49/00, 46/00 (LOW MODE), 76/00

24V RELAY & SWITCH  
TO BE SUPPLIED SEPERATELY



# ANTARES 7-INCH

## FOR POWERFUL PERFORMANCE IN A MORE COMPACT FORM.

The Antares 7-inch driving lights deliver outstanding visibility wherever the road takes you. Enjoy versatile lighting that's built for both adventure and everyday driving—without compromising on clarity or style.

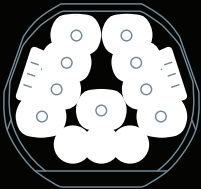

**HIGH  
OUTPUT  
MODE**



**DAYTIME  
RUNNING LIGHT**

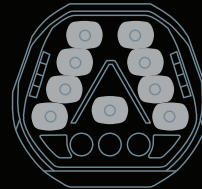

**POSITION  
LIGHT**

Ideal for smaller vehicles or tighter mounting spaces without sacrificing performance, the Antares 7 inch provides significant light output:

- 70m wide beam exceeds 110m distance, thanks to ultra-wide specific LED clusters
- Mid-range width of 56m that exceeds 400m distance with the umbrella LED optic
- Precision Projector LED gives a total distance exceeding 570m
- All at the industry standard of 1 lux

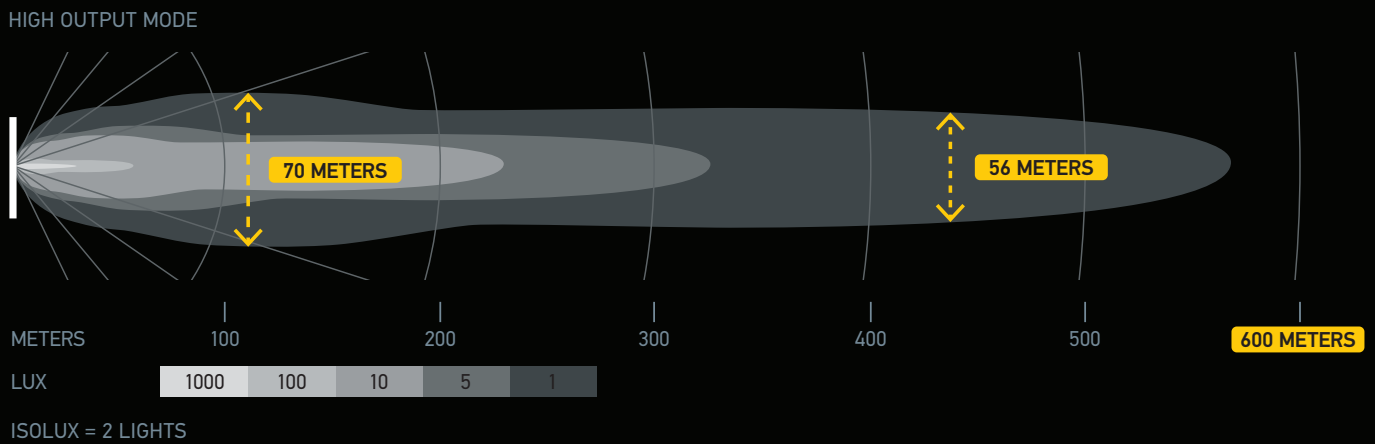

# ANTARES 7-INCH

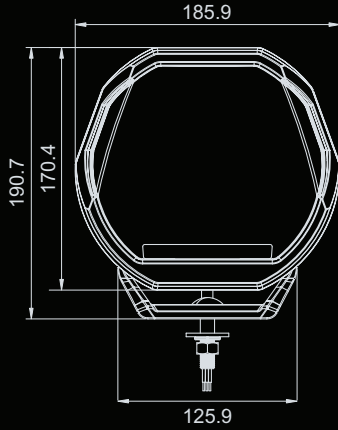

FRONT VIEW

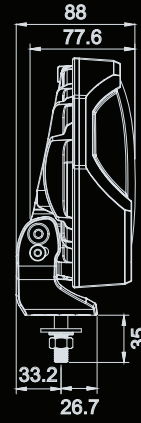

LEFT VIEW

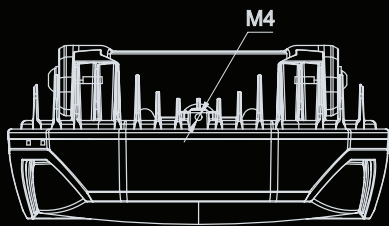

TOP VIEW

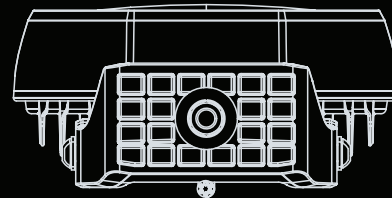

BOTTOM VIEW

## TECHNICAL INFORMATION FOR 1 LIGHT



HIGH OUTPUT  
MODE

13.5V: 9.64A±10%  
28V: 4.03A±10%

DAYTIME RUNNING  
LIGHT

13.5V: 0.56A±10%  
28V: 0.3A±10%

POSITION LIGHT

13.5V: 0.16A±10%  
28V: 0.11A±10%

24V

RELAY & SWITCH  
TO BE SUPPLIED SEPERATELY

## TECHNICAL INFORMATION FOR 1 LIGHT



1570 g

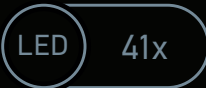

LED 41x

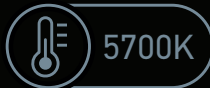

5700K



7400  
LUMEN



13000  
LUMEN



+ -  
10-30V  
DC



160W

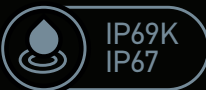

IP69K  
IP67



RoHS

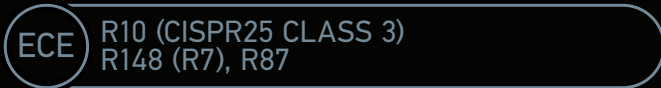

ECE R10 (CISPR25 CLASS 3)  
R148 (R7), R87

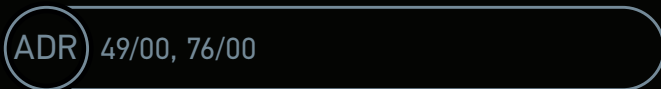

ADR 49/00, 76/00



## HELLA BLACK MAGIC

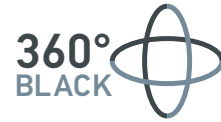

**High Level Light Output**  
Up to 20,000 effective lumens

**Versatile mounting**

- Upright/pendant
- Fully adjustable slide brackets also available

**Integrated Thermal Management**  
Thermal Management = high output  
Long Lasting LED performance

**Black out appearance**  
Unique design creates black out appearance without effecting performance



**Tough Construction**

- Tough design and fully sealed, protects against sand, dust and water!
- Suits harsh Australian conditions
- Tested to the exacting Hella Germany Rallye standard

**Impact Resistant PC Lens**

- UV stabilised to protect against sun damage
- Tested against high vibration resistance

# BLACK ON THE OUTSIDE.

# BRIGHT ON THE INSIDE.



**LEARN MORE ABOUT  
OUR BLACK MAGIC  
LIGHT BARS**

**HELLA Australia Pty. Ltd.**

4 Hargrave Place  
P.O. Box 89  
Mentone, Victoria, 3194 Australia

**HELLA New Zealand**

81 Ben Lomond Crescent  
Pakuranga, Auckland, 2010 New Zealand

Techline: 1800 061 729  
info.au@hella.com  
hellaorders@hella.com

**Find us at:**

facebook.com/hella.australia  
youtube.com/hellaaus  
instagram.com/hella.australia

© 2025 HELLA Australia Pty Ltd

hella.com/australiansolutions/en/  
hellacommunication.com.au/antares

